

# RENOGY REGO

## MPPT Solar Charge Controller

12V/24V | 30A

RCC2430REGO



VERSION A1  
April 15, 2025

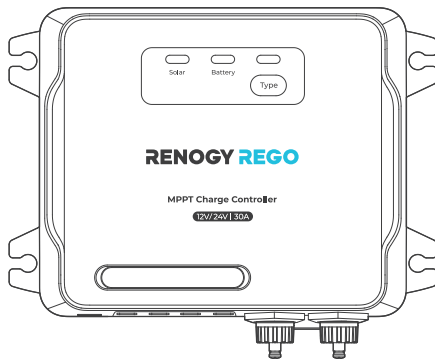

### QUICK GUIDE

## Before Getting Started

The quick guide provides important operation and maintenance instructions for RENOGY REGO 12V/24V 30A MPPT Solar Charge Controller (hereinafter referred to as charge controller).

Read the quick guide carefully before operation and save it for future reference. Failure to observe the instructions or precautions in the quick guide can result in electrical shock, serious injury, or death, or can damage the charge controller, potentially rendering it inoperable.

## Online Manual



Quick Guide



User Manual



## Table of Contents

<b>What's In the Box?</b> .....	<b>1</b>
<b>Dimensions</b> .....	<b>2</b>
<b>Get to Know Renogy Charge Controller</b> .....	<b>3</b>
<b>System Setup</b> .....	<b>4</b>
<b>How to Install Cables on the Charge Controller?</b> .....	<b>5</b>
<b>Required Tools</b> .....	<b>6</b>
<b>Step 1. Wear Insulating Gloves</b> .....	<b>6</b>
<b>Step 2. Plan a Mounting Site</b> .....	<b>7</b>
<b>Step 3. Connect the Charge Controller to a Battery</b> .....	<b>8</b>
<b>Step 4. Connect the Charge Controller to a Solar Panel</b> .....	<b>10</b>
<b>Step 5. Install a Battery Temperature Sensor</b> .....	<b>12</b>
<b>LED Indicators</b> .....	<b>13</b>
<b>Set a Battery Type</b> .....	<b>15</b>
<b>USER Mode</b> .....	<b>16</b>

<b>Monitor the Battery Charger</b> .....	<b>17</b>
Short-Range Monitoring via the Renogy App .....	18
Wireless Long-Range Monitoring.....	19
<b>Troubleshooting</b> .....	<b>20</b>
<b>Important Safety Instructions</b> .....	<b>21</b>
<b>Renogy Support</b> .....	<b>23</b>
<b>FCC Statement</b> .....	<b>25</b>
<b>FCC Radiation Exposure Statement</b> .....	<b>26</b>
<b>Disclaimer</b> .....	<b>26</b>

## What's In the Box?

RENOGY REGO 12V/24V 30A  
MPPT Solar Charge Controller x 1

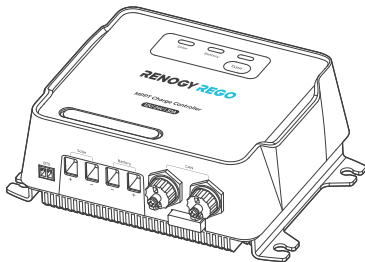

Quick Guide x 1

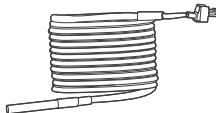

Battery Temperature  
Sensor (3 m) x 1

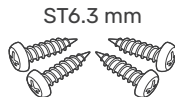

ST6.3 mm  
Mounting Screws x 4



Make sure that all accessories are complete and free of any signs of damage.



The accessories and product manual listed are crucial for the installation, excluding warranty information and any additional items. Please note that the package contents may vary depending on the specific product model.

## Dimensions

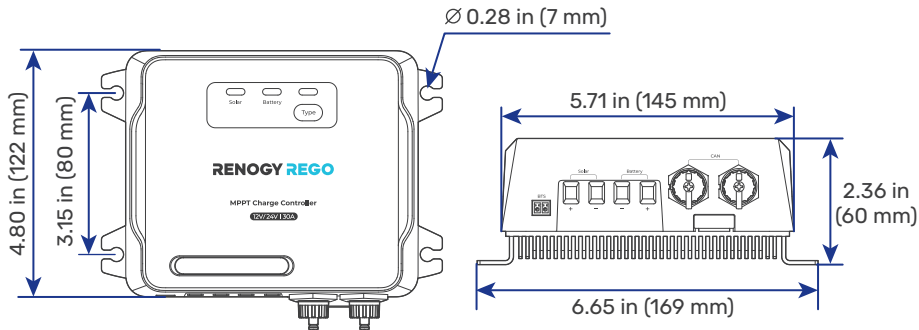

Dimension tolerance:  $\pm 0.2$  in (0.5 mm)

## Get to Know Renogy Charge Controller

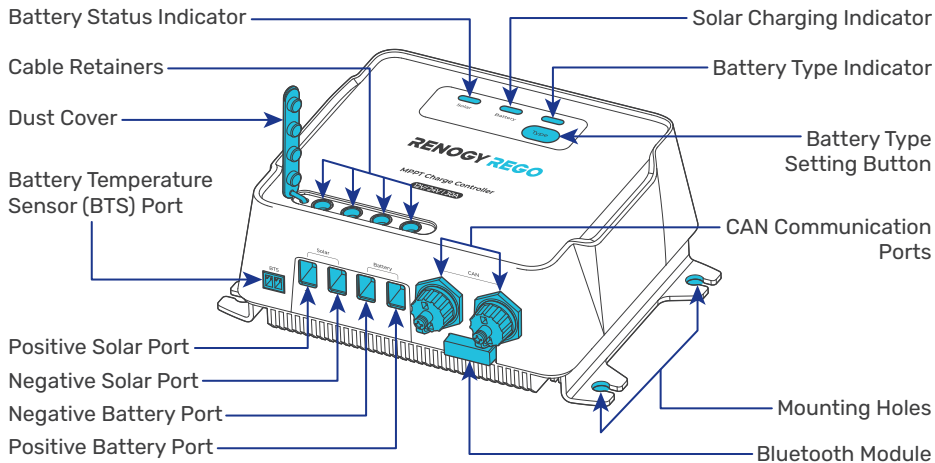

The Battery Temperature Sensor (BTS) Port cannot be used on lithium iron phosphate batteries which come with battery management systems (BMS).

## System Setup

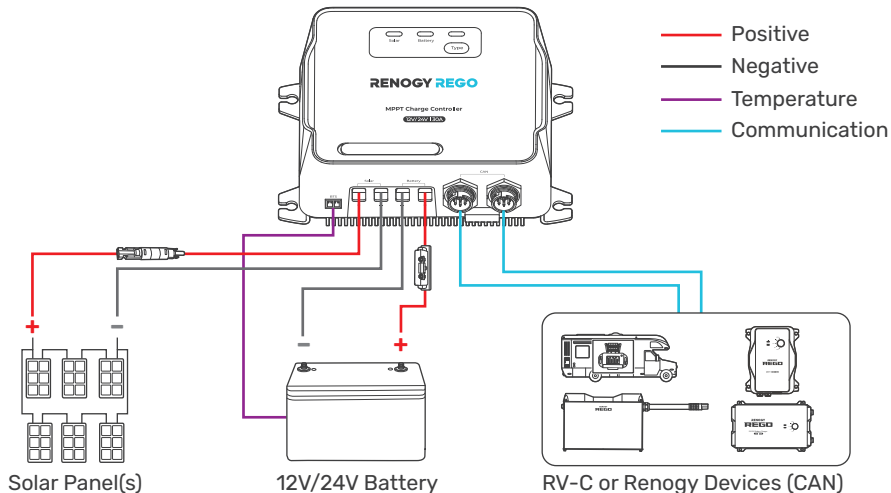

For wiring details of the CAN Communication Ports, please scan the QR code found in the Online Manual at the beginning of this manual or visit [Renogy Support Downloads](#).

## How to Install Cables on the Charge Controller?

The illustrations are based on the Positive Battery Cable, and the same rules apply to other cables. In this guide, we use a red wire for positive, and a black wire for negative.

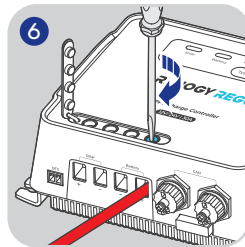
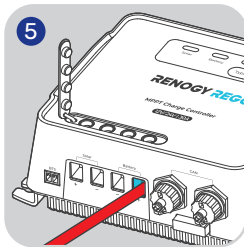
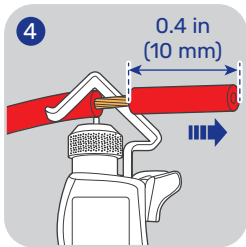
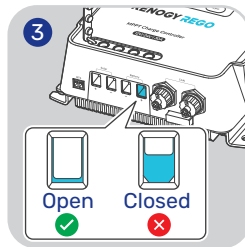
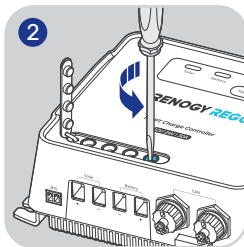
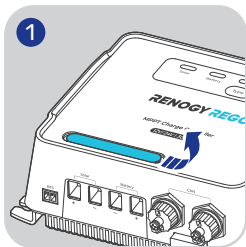

## Required Tools



Phillips  
Screwdriver (#2)



Slotted  
Screwdriver (5 mm)

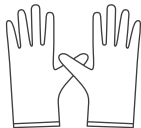

Insulating  
Gloves

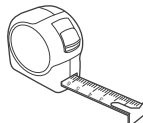

Measuring  
Tape



Wire  
Stripper



Prior to installing and configuring the charge controller, prepare the recommended tools, components, and accessories.

## Step 1. Wear Insulating Gloves

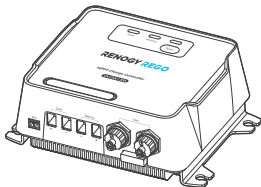

Insulating Gloves

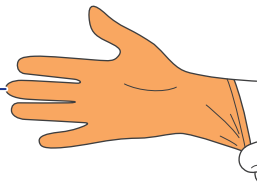

## Step 2. Plan a Mounting Site

The charge controller requires adequate clearance for installation, wiring, and ventilation. The minimum clearance is provided below. The charge controller can be mounted either on a floor or on a wall.

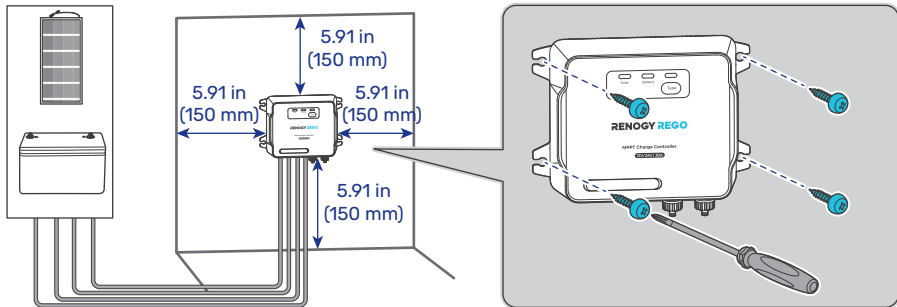

-22°F to 176°F / -30°C to 80°C  
(Power reduction above 113°F / 45°C)



0% to 95%



The charge controller should be installed on a flat surface protected from direct sunlight.

### Step 3. Connect the Charge Controller to a Battery

The charge controller can be connected to deep-cycle gel-sealed lead-acid batteries (GEL), flooded lead-acid batteries (FLD), sealed lead-acid batteries (SLD/AGM) or lithium iron phosphate batteries (LI).

#### Recommended Components & Accessories

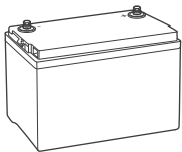

\*12V/24V  
Battery

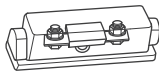

\*ANL Fuse  
(40A) × 1

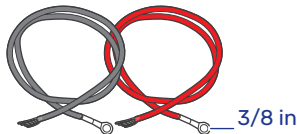

Battery Adapter  
Cables (10 AWG) × 2



Fuse Cable  
(10 AWG) × 1



Accessories marked with "\*" are available on [renogy.com](https://www.renogy.com).



For installation details, see the user manual of the battery in use.



To ensure optimal system performance, a 10 AWG cable should be no longer than 3 meters. Choose higher gauge cables for longer distances. For details, see the user manual of the charge controller at [www.renogy.com/support/downloads](https://www.renogy.com/support/downloads).

### STEP-1 Install cables on the charge controller

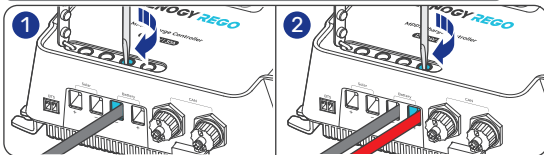

### STEP-2 Install an ANL fuse

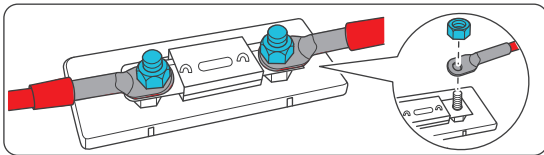

### STEP-3 Install the cables on the battery

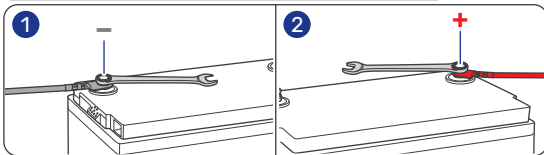

**⚠ Negative First!**

Battery  
Adapter  
Cables

ANL  
Fuse  
(40A)

Fuse  
Cable

12V/24V Battery

## Step 4. Connect the Charge Controller to a Solar Panel

### Recommended Components & Accessories

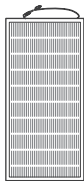

\*Solar Panel (s)  
(14V to 100V, 30A Max)

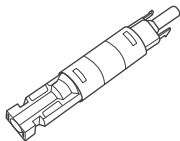

\*Solar Panel Fuse



\*Solar Panel to Charge Controller  
Adaptor Kit (10 AWG, Max power) × 1

<b>Battery Nominal Voltage</b>	12V	24V
<b>Rated Charge Power</b>	≤ 450W	≤ 900W



Accessories marked with "\*" are available on [renogy.com](https://www.renogy.com).



Connecting the charge controller to a solar panel exceeding 100V results in damage to the charge controller.



The appropriate current rating for the solar panel fuse should be determined by multiplying the total amperage of the solar panel array by 1.56.

### STEP-1 Install cables on the charge controller



### STEP-2 Install a solar panel fuse

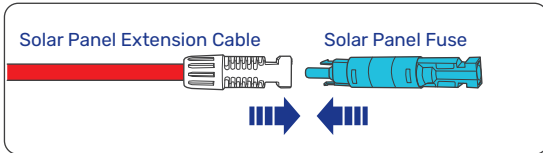

### STEP-3 Install cables on the solar panel(s)

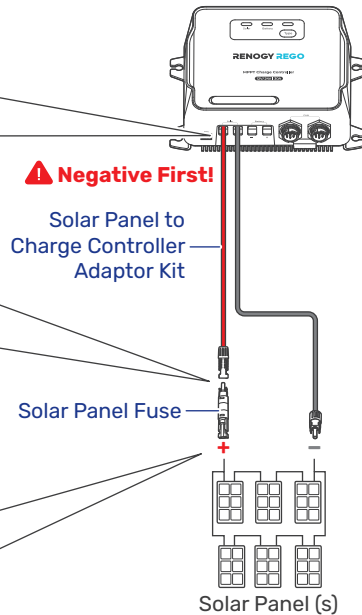
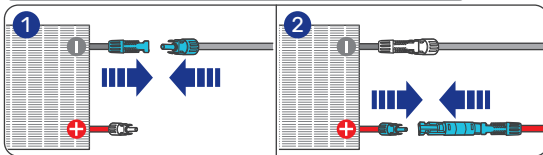

## Step 5. Install a Battery Temperature Sensor

The temperature sensor measures the surrounding temperature of the battery and compensates the floating charge voltage when the battery temperature is low.



Do not use the temperature sensor on a LiFePO4 (LFP) battery which comes with a battery management system (BMS).

Mount the sensor securely at a suitable location in close proximity to the battery.

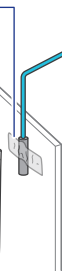
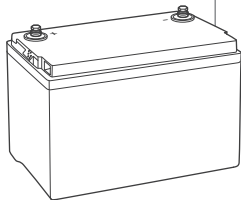

Battery Temperature Sensor

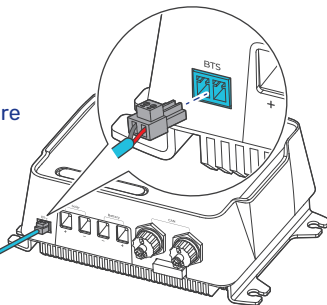

## LED Indicators

The charge controller turns on automatically after power on with the LED indicators working in accordance with the relative operational status.

### Solar Charging Indicator

- Off:** No solar panel detected
- Solid:** Charging

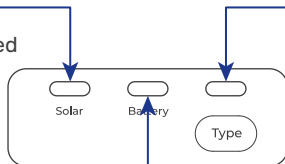

### Battery Status Indicator

- Off:** No battery detected
- Solid:** Fully charged
- Slow Flash:** Charging
- Solid:** Not charged and the battery is not fully charged
- Solid:** Overdischarge protection
- Slow Flash:** Overvoltage protection
- Fast Flash:** Overtemperature protection on battery
- Jumping Flash:** Overtemperature protection on charge controller



### Battery Type Indicator

- Solid:** SLD/AGM
- Solid:** 12V LI (lithium battery activation enabled)
- Flash:** 12V LI (lithium battery activation disabled)
- Solid:** 24V LI (lithium battery activation enabled)
- Flash:** 24V LI (lithium battery activation disabled)
- Solid:** User Mode
- Solid:** FLD
- Solid:** GEL

## Graphic indications of ON and OFF

<b>LED ON</b>		<b>LED OFF</b>	
---------------	---	----------------	---

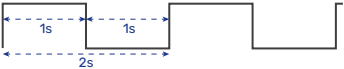
## Graphic expression of Solid, Slow Flash, Fast Flash, and Jumping Flash

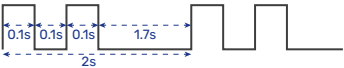
LED Pattern	Description	Graphic Expression
Solid	The LED remains continuously illuminated without any variation.	
Slow Flash	In this mode, the LED alternates between being on and off at a relatively slow and regular interval of 1s.	
Fast Flash	In this mode, the LED alternates between being on and off at a relatively fast and regular interval of 0.1s.	
Jumping Flash	In this mode, the LED alternates between brief 0.1s on-off cycles followed by a longer 1.7s off period.	

## Set a Battery Type

Upon installing the charge controller, set a correct battery type by using the Battery Type Setting Button. For non-lithium batteries, the charge controller can automatically detect their voltage (12V or 24V).



It is essential to ensure that the battery type setting is configured correctly to avoid any potential damage to the charge controller because any damage to the charge controller resulting from an incorrect battery type setting voids the warranty.

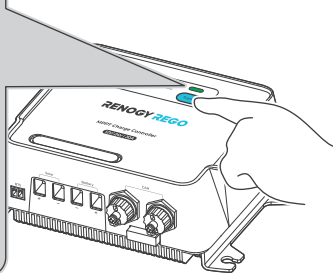
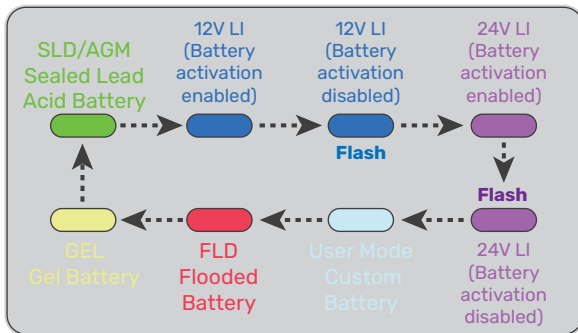

## USER Mode

Setting the battery type to User Mode allows you to customize your battery parameters. You can modify the parameters in the Renogy app.

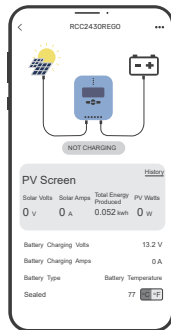
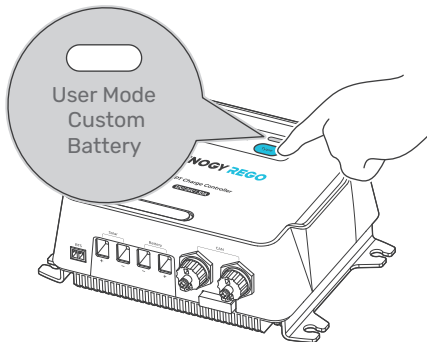

When customizing settings, consult the user manual of the specific battery. If necessary, contact the manufacturer for further assistance.





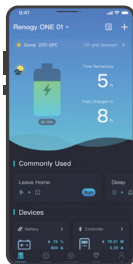

For detailed parameter settings, please scan the QR code found in the Online Manual at the beginning of this manual or visit [Renogy Support Downloads](#).

## Monitor the Battery Charger

Download the Renogy app. Login to the app with your account.



-  For CAN communication details, please scan the QR code found in the Online Manual at the beginning of this manual or visit [Renogy Support Downloads](#).
-  The version of the Renogy app might have been updated. Illustrations in the user manual are for reference only. Follow the instructions based on the current app version.
-  To ensure optimal system performance, keep the phone or RENOGY ONE within 10 feet (3 m) of the charge controller.
-  You can receive fault alarms on the Renogy app when the charge controller is faulty. Please login to the Renogy app for troubleshooting details.

## Short-Range Monitoring via the Renogy App

Pair the charge controller with the Renogy app. Monitor and modify the parameters of the charge controller via the app.

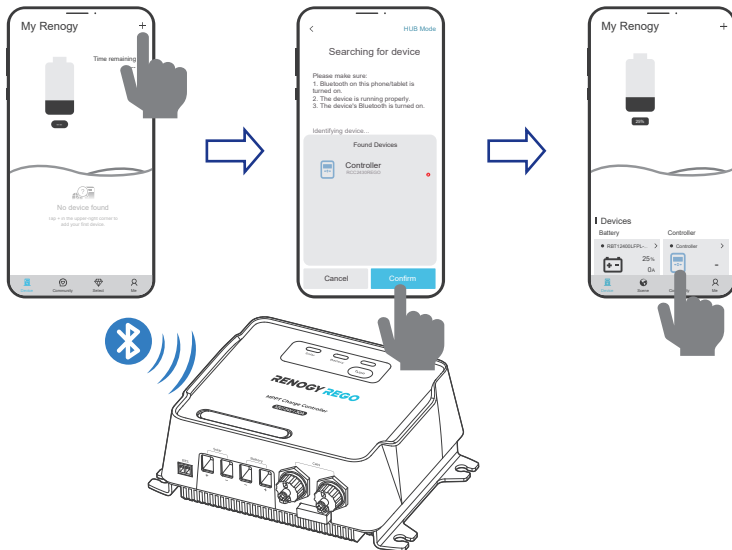

## Wireless Long-Range Monitoring

### Recommended Components



\*RENOGY ONE Core

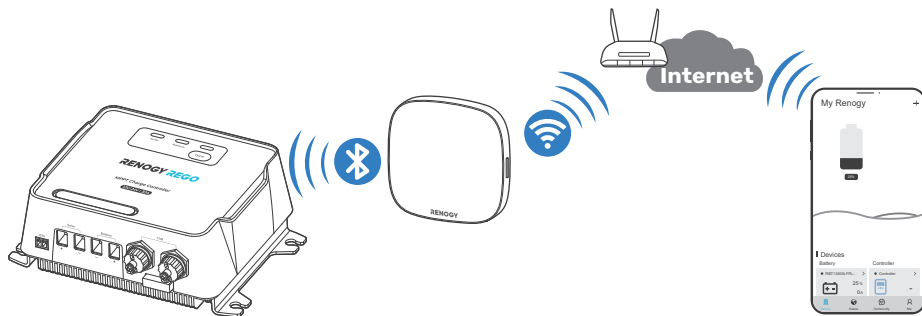

## Troubleshooting

You can receive fault alarms on the Renogy app when the charge controller is faulty. Please login to the Renogy app for troubleshooting details.

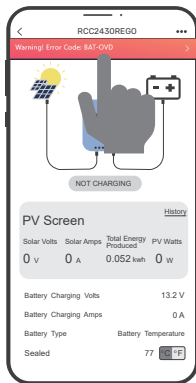

For technical support, contact our technical service through [renogy.com/contact-us](https://www.renogy.com/contact-us).

## Important Safety Instructions

### ■ General

- Wear proper protective equipment and use insulated tools during installation and operation. Do not wear jewelry or other metal objects when working on or around the charge controller.
- Keep the charge controller out of the reach of children.
- Do not dispose of the charge controller as household waste. Comply with local, state, and federal laws and regulations and use recycling channels as required.
- In case of fire, put out the fire with a FM-200 or CO<sub>2</sub> fire extinguisher.
- Installing the charge controller improperly on a boat may cause damage to components of the boat. Have the devices installed by a qualified electrician.
- Do not expose the charge controller to flammable or harsh chemicals or vapors.
- Clean the charge controller regularly.
- Do not puncture, drop, crush, penetrate, shake, strike, or step on the charge controller.
- Do not open, disassemble, repair, tamper with, or modify the charge controller.
- Connect the negative prior to the positive terminal when connecting any device.
- It is recommended that all cables should not exceed 10 meters because excessively long cables result in a voltage drop.
- The cable specifications listed in the quick guide account for critical, less than 3% voltage drop and may not account for all configurations.

## ■ Charge Controller Safety

- Install the charge controller on a vertical surface - protected from direct sunlight, high temperatures, and water. Make sure there is good ventilation.
- Keep the charge controller away from heating equipment.
- Do not insert foreign objects into the charge controller.
- Confirm the polarities of the devices before connection. A reverse polarity contact can result in damage to the charge controller, thus voiding the warranty.
- Do not touch the connector contacts while the charge controller are in operation.
- Disconnect all connectors from the charge controller before maintenance or cleaning.

## ■ Battery Safety

- Do not use batteries if there is any damage.
- Do not touch the exposed electrolyte or powder if the battery is damaged.
- Risk of explosion! Never install the charge controller in a sealed enclosure with flooded batteries! Do not install the charge controller in a confined area where battery gases can accumulate.
- Prior to installing the charge controller, ensure all battery groups are installed properly.

## ■ Solar Panel Safety

- Do not use the solar panel(s) if there is any damage.
- Prior to connecting the charge controller to the solar panel(s), shade the solar panel(s).
- Always connect the charge controller to the battery first before connecting it to the solar panel. This prevents damage caused by open-circuit voltage from the solar panel.

## Renogy Support

To discuss inaccuracies or omissions in this quick guide or user manual, visit or contact us at:

 | [renogy.com/support/downloads](https://renogy.com/support/downloads)



→ [contentservice@renogy.com](mailto:contentservice@renogy.com)

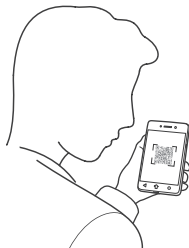

Questionnaire Investigation



To explore more possibilities of solar systems, visit Renogy Learning Center at:

 | [renogy.com/learning-center](https://renogy.com/learning-center)



**For technical questions about your product in the U.S.,** contact the Renogy technical support team through:

 | [renogy.com/contact-us](https://renogy.com/contact-us)



1(909)2877111

**For technical support outside the U.S.,** visit the local website below:

**Canada** |  | [ca.renogy.com](https://ca.renogy.com)

**Australia** |  | [au.renogy.com](https://au.renogy.com)

**Other Europe** |  | [eu.renogy.com](https://eu.renogy.com)

**United Kingdom** |  | [uk.renogy.com](https://uk.renogy.com)

**China** |  | [www.renogy.cn](https://www.renogy.cn)

**Japan** |  | [jp.renogy.com](https://jp.renogy.com)

**Germany** |  | [de.renogy.com](https://de.renogy.com)

## FCC Statement

This device complies with Part 15 of the FCC Rules. Operation is subject to the following two conditions:

- (1) This device may not cause harmful interference.
- (2) This device must accept any interference received, including interference that may cause undesired operation.

Any Changes or modifications not expressly approved by the party responsible for compliance could void the user's authority to operate the equipment.

This equipment has been tested and found to comply with the limits for a Class B digital device, pursuant to Part 15 of the FCC Rules. These limits are designed to provide reasonable protection against harmful interference in a residential installation. This equipment generates, uses and can radiate radio frequency energy and, if not installed and used in accordance with the instructions, may cause harmful interference to radio communications. However, there is no guarantee that interference will not occur in a particular installation. If this equipment does cause harmful interference to radio or television reception, which can be determined by turning the equipment off and on, the user is encouraged to try to correct the interference by one or more of the following measures:

- (1) Reorient or relocate the receiving antenna.
- (2) Increase the separation between the equipment and receiver.
- (3) Connect the equipment into an outlet on a circuit different from that to which the receiver is connected.
- (4) Consult the dealer or an experienced radio/TV technician for help.

## FCC Radiation Exposure Statement

This equipment complies with FCC radiation exposure limits set forth for an uncontrolled environment. This equipment should be installed and operated with minimum distance 20cm between the radiator & your body.

## Disclaimer

RENOGY REGO 12V/24V 30A MPPT Solar Charge Controller Quick Guide © 2025 Renogy. All rights reserved.

**RENOGY** and **RENOGY** are registered trademarks of Renogy.

- All information in the quick guide is subject to copyright and other intellectual property rights of Renogy and its licensors. The quick guide may not be modified, reproduced, or copied, in whole or in part, without the prior written permissions of Renogy and its licensors.
- The registered trademarks in the quick guide are the property of Renogy. The unauthorized use of the trademarks is strictly prohibited.
- Renogy ensures the accuracy, sufficiency, and the applicability of information in the quick guide at the time of printing due to continual product improvements that may occur.

- Renogy assumes no responsibility or liability for personal and property losses, whether directly and indirectly, caused by the user's failure to install and use the product in compliance with the quick guide.
- Renogy is not responsible or liable for any failure, damage, or injury resulting from repair attempts by unqualified personnel, improper installation, and unsuitable operation.
- The illustrations in the quick guide are for demonstration purposes only. Details may appear slightly different depending on product revision and market region.
- Renogy reserves the right to change the information in the quick guide without notice. For the latest quick guide, visit [renogy.com](http://renogy.com).

Manufacturer: RENOGY New Energy Co.,Ltd  
Address: No.66, East Ningbo Road Room 624-625 Taicang German  
Overseas Students Pioneer Park JiangSu 215000 CN



eVatmaster Consulting GmbH  
Raiffeisen Street2 B11, 63110  
Rodgau,Hessen,Germany  
contact@evatmaster.com

Manufacturer: RENOGY New Energy Co.,Ltd  
Address: No.66, East Ningbo Road Room 624-625 Taicang German  
Overseas Students Pioneer Park JiangSu 215000 CN



EVATOST CONSULTING LTD  
Office 101 32 Threadneedle Street,  
London, United Kingdom, EC2R 8AY  
contact@evatost.com

## Renogy Power **PLUS**

Renogy Power Plus allows you to stay in the loop with upcoming solar energy innovations, share your experiences with your solar energy journey, and connect with like-minded people who are changing the world in the Renogy Power Plus community.



@Renogy Solar



@renogyofficial



@Renogy

Renogy reserves the right to change the contents of this quick guide without notice.



RENOGY.COM

 **RENOGY**